

User Manual

■ DTU-Pro



Contents



1. Important Safety Information	3
1.1 Read this First	3
1.2 Safety Instructions	3
1.3 User.....	3
1.4 Support and Contact Information.....	3
1.5 Other Information.....	4
2. Hoymiles Microinverter System.....	4
2.1 Microinverter	4
2.2 DTU.....	4
2.3 Hoymiles Monitoring Server	4
3. Interface Layout.....	5
3.1 For DTU-Pro (GPRS Version).....	5
3.2 For DTU-Pro (WiFi Version).....	5
3.3 Zero Export Function (RS485 port)	6
3.4 Remote active power control(RS485 port).....	7
3.5 DRM Port	7
3.6 Local Install Assistant.....	8
4. DTU Installation	8
4.1 System Capacity	8
4.2 Basic Conditions Required	8
4.3 Dimensions	9
4.4 System Installation Sequence.....	10
4.5 Preparation	10
4.6 Install the DTU.....	11
5. Complete Installation Map	14
6. Site Creation on HMP	15
7. Customer Login	15
8. Browse the Web Station.....	15
9. View Phone APP	16
10. LED Indicators	17
11. Technical Data.....	18

1. Important Safety Information

1.1 Read this First

This manual includes important instructions for installing and maintaining the Hoymiles Data Transfer Unit (DTU-Pro).

1.2 Safety Instructions

Symbol	Usage
	Indicate a hazardous situation that can result in deadly electric shock hazards, other serious physical injuries, or fire hazards.
	Indicate directions that must be fully understood and followed entirely to avoid potential safety hazards including equipment damage or personal injury.
	Indicate that the described operation must not be carried out. The reader should stop, use caution, and fully understand the operations explained before proceeding.

- Note that only professionals can install or replace DTU.
- Do not try to repair DTU without Hoymiles' approval. If DTU is damaged, please send the DTU back to your installer for repairing/replacing. Disassembling DTU without Hoymiles' approval will invalidate remaining of the warranty period.
- Please read all instructions and warnings on the technical specifications carefully.
- Do not use Hoymiles products in a way that is not suggested by manufacture. Doing so may cause death or injury to persons or damage to equipment.

1.3 User

This manual is only for professional installation and maintenance personnel to use.

1.4 Support and Contact Information

If you have technical queries concerning our products, please contact your system's installer or distributor. If further support is required, please contact Hoymiles' support at this link.

- www.hoymiles.com
- Hoymiles' customer service center: service@hoymiles.com

1.5 Other Information

Product information is subject to change without notice. The user manual will be updated frequently; please refer to Hoymiles official website at www.hoymiles.com for the latest version.

2. Hoymiles Microinverter System

2.1 Microinverter

It converts the DC output of PV modules into grid-compliant AC power. It sends the output information of PV modules and the operation data of the microinverters to the DTU, which is the hardware basis of the module-level monitoring. With conversion efficiency up to 96.7% and MPPT efficiency up to 99.9%, Hoymiles microinverters rank into the first class of the world's microinverter industry.

2.2 DTU

The DTU is the key component in Hoymiles microinverter system. It works as the communication gateway, which operates between the Hoymiles microinverters and the Hoymiles Monitoring Server. The DTU communicates with the microinverter wirelessly via 2.4GHz Proprietary RF (Nordic), collecting the operation data of the system. Meanwhile, the DTU connects to the Internet via router and communicates with Hoymiles Monitoring Server. The microinverter system operation data will be uploaded to Hoymiles Monitoring Server via DTU.

2.3 Hoymiles Monitoring Server

It collects the operation data and status of the microinverters in the system and provides the module-level monitoring for the users and maintenance staff. The following diagram shows the Hoymiles Microinverter system.

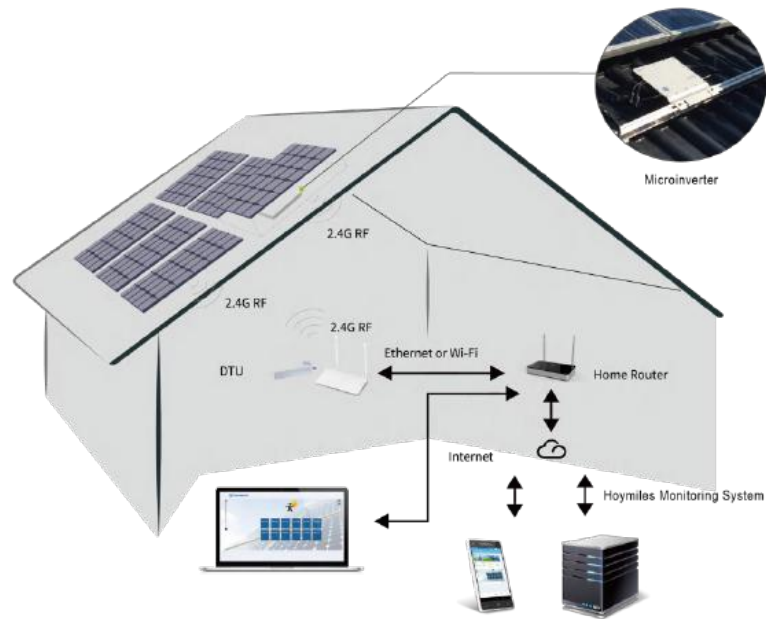

3. Interface Layout

3.1 For DTU-Pro (WIFI Version)

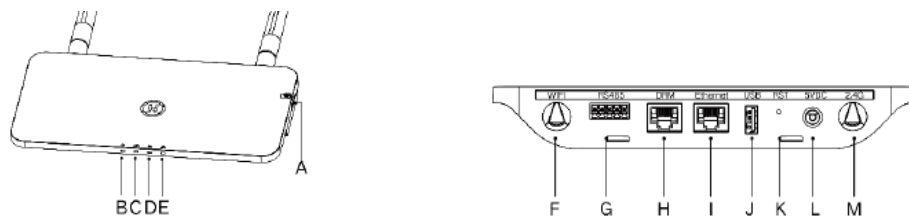

Item	Description
A	SD Card Slot
B	DTU Power Indicator
C	DTU Communication Indicator (With Server)
D	DTU Communication Indicator (With MI)
E	DTU Alarm Indicator
F	WiFi Antenna (2.4G)
G	RS485
H	DRM Port (For Australia only)
I	Ethernet Port
J	USB Port
K	Reset Bottom
L	Power Port
M	2.4G Antenna

3.2 For DTU-Pro (GPRS Version)

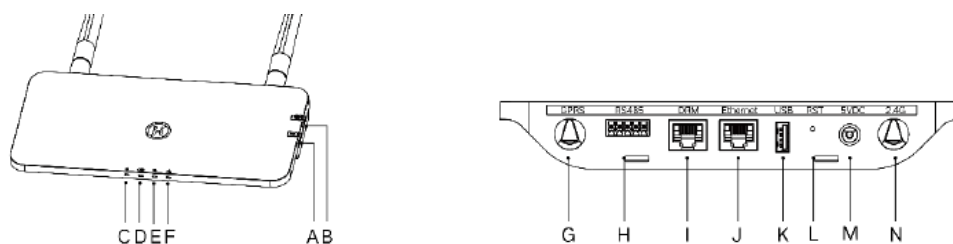

Item	Description
A	SIM Card Slot
B	SD Card Slot
C	DTU Power Indicator
D	DTU Communication Indicator (With Server)
E	DTU Communication Indicator (With MI)
F	DTU Alarm Indicator
G	GPRS Antenna (GSM)
H	RS485
I	DRM Port (For Australia only)
J	Ethernet Port
K	USB Port
L	Reset Bottom
M	Power Port
N	2.4G Antenna

3.3 Export Management Function (RS485 port)

a. Device Required.

- Hoymiles Microinverter: 4 in 1 Unit, 2 in 1 Unit and Single Unit
- DTU: DTU-Pro:
- Meter: Chint Meter (DDSU666)/Chint Meter (DTSU666)/CCS WattNode Meter

b. Export Control Type.

- Type 1: Zero Export: to limit the exporting power to zero so that can prevent the generated power feed back to the grid.
- Type 2: Export Limit: to limit the exporting power within a certain value.
- Type 3: Production and Consumption Monitoring: enable to measure the PV generating under a high accuracy.

c. Installation Diagram.

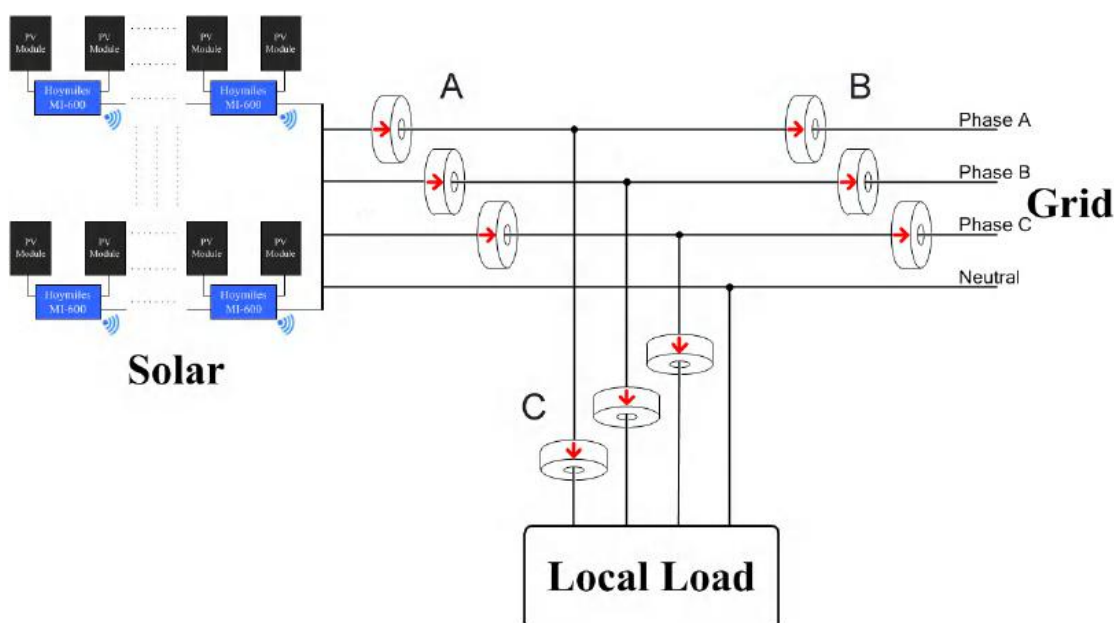

Note: Please refer to “Hoymiles Export Management Technical Note” for more details.

3.4 Remote active power control (RS485 port)

In some countries, it might require that the generating plants should be equipped with a logic interface (input port) in order to cease output active power or limit active power to a regulating level. This logic input can be RS485 port, Ethernet port, etc. DTU-Pro provide RTU Modbus protocol over RS485 port for this remote active power control. For more information, please refer to “Modbus implementation Technical Note” .

3.5 DRM Port

DRM port is provided to support several demand response modes as below by connecting external control device with a standard RJ-45 connector. For DTU-Pro, it can support DRM0/5/6/7/8 if used with Hoymiles microinverters.

Mode	Requirement
DRM0	Operate the disconnection device
DRM1	Do not consume power
DRM2	Do not consume at more than 50% of rated power
DRM3	Do not consume at more than 75% of rated power AND Source reactive power if capable
DRM4	Increase power consumption (subject to constraints from other active DRMs)
DRM5	Do not generate power
DRM6	Do not generate at more than 50% of rated power
DRM7	Do not generate at more than 75% of rated power AND Sink reactive power if capable
DRM8	Increase power generation (subject to constraints from other active DRMs)

3.6 Local Install Assistant

Local Install Assistant is a new function integrated with DTU-Pro, please download the Installer App (for installer/distributor use only) first.



DTU-Pro has improved from the previous generation of DTU product, and developed with this new function that allows installer:

- a. One step to complete the WiFi configuration;
- b. Station overall Inverters status indication allows the installer to see how many MI under this DTU is working properly (and the details for each MI) and how many is abnormal (and the details for each MI) with one glance of eyes;
- c. Add the Connection status, which will display the signal strength between each MI with connected DTU, so that installer can adjust the DTU installation location accordingly. This function will simplify the DTU installation, and avoid the second visit for installer due to the poor connection between DTU and certain MI.

Note: Please refer to “Hoymiles Local Install Assistant Technical Note” for more details.

4. DTU Installation

4.1 System Capacity

The DTU-Pro is capable of monitoring up to 99 panels. If the communication between the DTU and microinverter caused by the installation conditions, the number of PV modules that the DTU can monitor may be reduced.

Note: Max. monitoring quantity is for open space, installation condition meets the requirement from both DTU and Microinverter manual, and the distance between Microinverter and DTU needs to be within the required range.

4.2 Basic Conditions Required

Before installing the DTU, ensure that the site meets the following requirements:

- Standard 220 VAC power outlet.

- Stable broadband internet connection.
- Router with Ethernet port.

The environmental requirements for DTU installation:

- Away from dust, liquid, acidic, or corrosive gas.
- The temperature should be between -20°C and 55°C.

If you plan to install the DTU on the wall, please prepared two #8 (4.166mm diameter) screws and a screwdriver in advance.

4.3 Dimensions

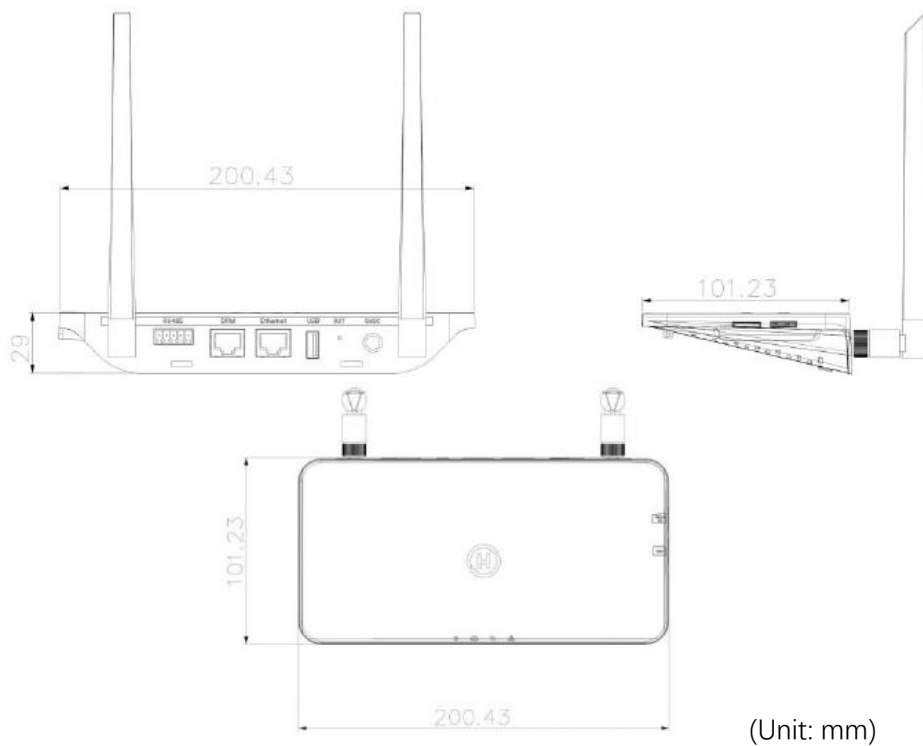

4.4 System Installation Sequence

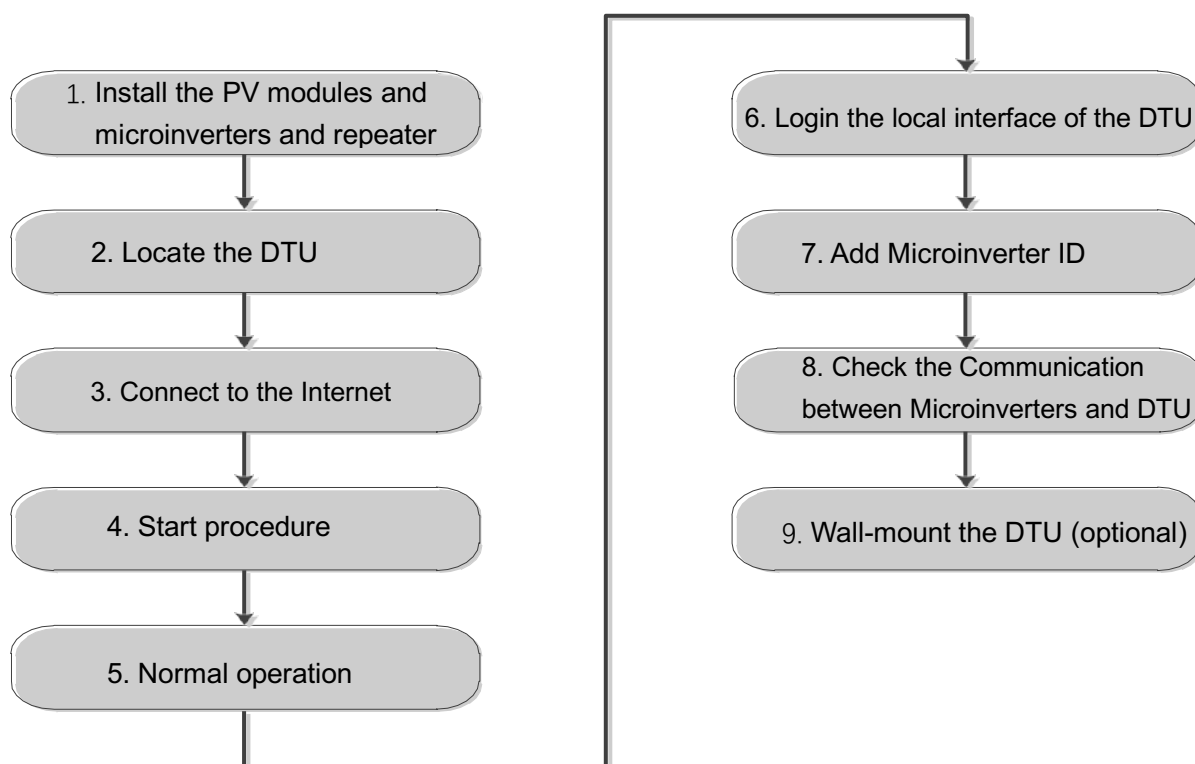

4.5 Preparation

A. Download the Hoymiles mobile App



B. Check the box for following items:

- Hoymiles DTU-Pro
- Two Antennas
- Adapter
- Bracket
- 5 Pin Plug

C. Choose the way DTU-Pro connect to the Internet:

- For **DTU-Pro (WiFi Version)**:

Use WiFi or Ethernet. Please prepare for the following items, if needed:

- Ethernet Cable (if choose Ethernet option).
- Hoymiles Installer App.

- **For DTU-Pro (GPRS Version):**

Use GPRS or Ethernet. Please prepare for the following items, if needed:

- SIM Card (if choose GPRS option)
- Ethernet Cable (if choose Ethernet option)
- Hoymiles Installer App.

4.6 Install the DTU

Step 1: Install the antennas

- **For DTU-Pro (WiFi Version):**

Take two 2.4G antennas out from the box, screw the antenna into the WiFi port and 2.4G port.

- **For DTU-Pro (GPRS Version):**

Take 2.4G antenna and GSM antenna out from the box, screw the antenna into the GPRS port and 2.4G port.

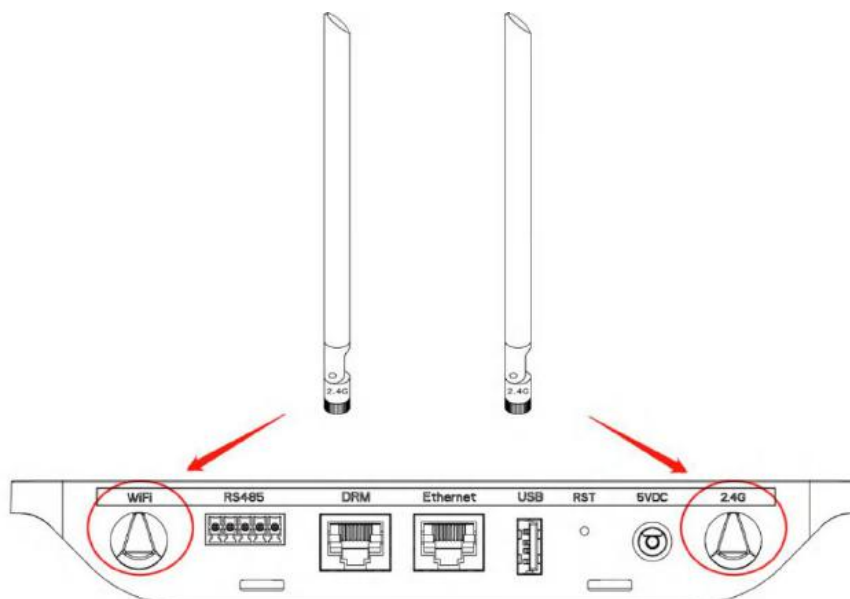

Note : If the DTU installation location is inside the metal box or under the metal / concrete roof, extended 2.4G cable or 2.4G sucker antenna will be suggested, which can be purchased from Hoymiles or local electrical store (Please contact Hoymiles’s Tech. support team for the detail type of the cable or antenna at support@hoymiles.com).

Step 2: Insert the SIM Card into the SIM Card slot on the side of DTU, press the SIM Card in until you heard “Click” (For DTU-Pro GPRS only).

Step 3: Choose an Installation Location

- Installed on the top floor to increase the signal strength.
- Installed near the center of the PV array.
- Installed at least 0.5m above the ground and more than 0.8m away from the corner.

Note: Please do not install the DTU direct above the metal or concrete to prevent the signal dilution.

Step 4: Choose the Installation Method**Option 1:** Mount the DTU on the wall.

- Screw the bracket on the wall, please choose at least two screw holes (one from each side) to fix the bracket (the M4 screws need to prepare by installer);

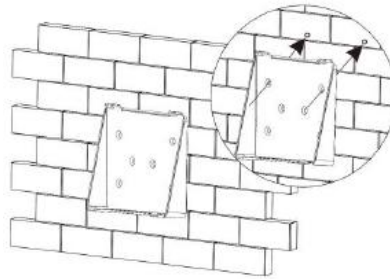

- Match the bracket's upper buckle with DTU-Pro;

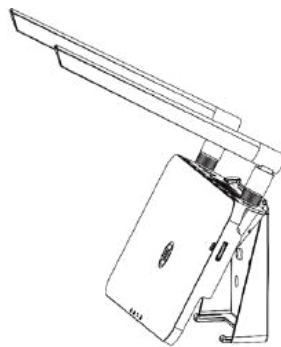

- Match the bracket's lower buckle by gently press the lower side of the DTU-Pro until hear the Click. Please make sure the antennas are vertical to the wall.

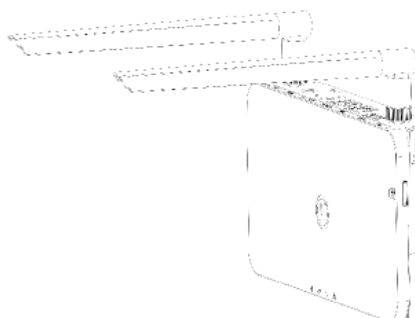

Option 2: Place the DTU on the table

- Place the DTU on the table, please make sure the antennas are vertical to the table;

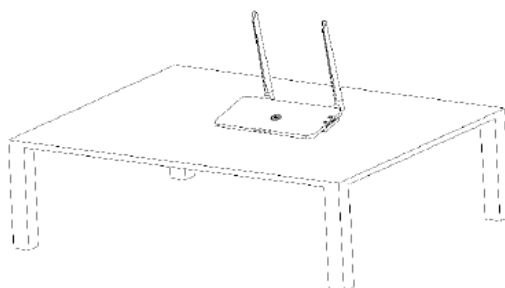

- a. Plug in the power adapter to power the DTU;
- b. Set up with Internet.

- **For DTU-Pro (WiFi Version):**

- a. Use the smart phone/tablet open the Installer App and login. Approach to “Me” on the bottom of the page and then “Network Configuration” . And complete the WiFi configuration (If choose WiFi);
- b. Use the Lan Cable, one side connect with house router, another side with DTU Ethernet port. Use the smart phone/tablet open the Installer App and login. Approach to “Me” on the bottom of the page and then “Network Configuration”, select “Ethernet” (If choose Ethernet).

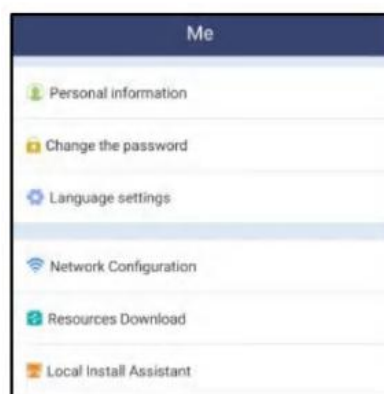

- **For DTU-Pro (GPRS Version):**

- a. Use the Lan Cable, one side connect with house router, another side with DTU Ethernet port. Use the smart phone/tablet open the Installer App and login. Approach to “Me” on the bottom of the page and then “Network Configuration”, select “Ethernet” (If choose Ethernet).
- b. If choose GPRS, our default APN is CMNET, in terms of your country do not support CMNET please modify the APN at: “Me-Local Install Assistant-Cloud-Network Configuration” from the Installer App.

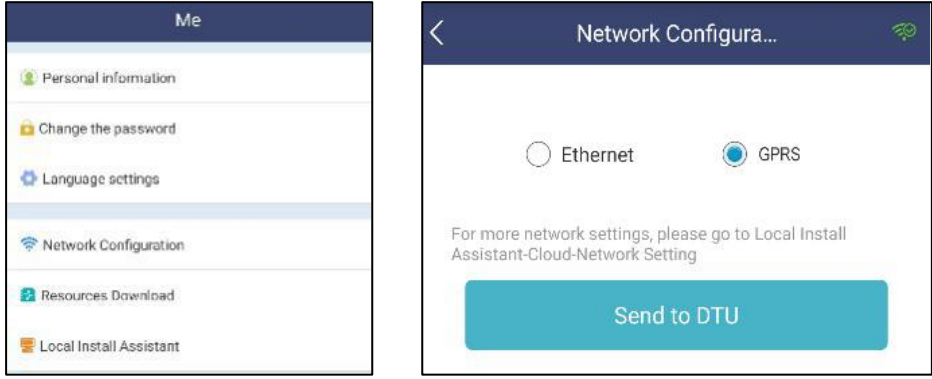

5. Complete Installation Map

Please complete the installation map.

- A) Peel the serial number label (as circled below) from the DTU and place it on the installation map.

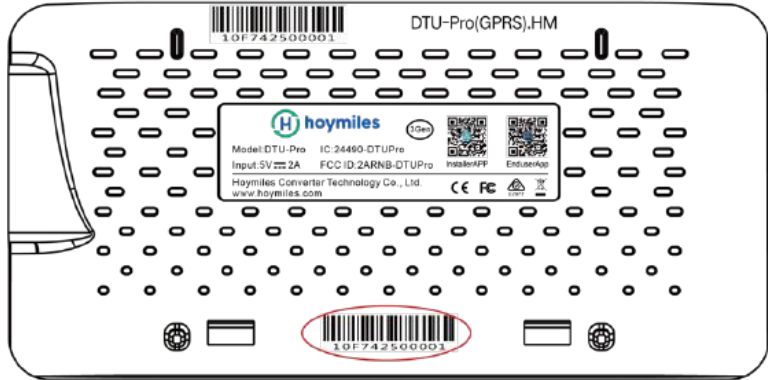

- B) Complete system information of the installation map shown as follows.

To sheet _____															
	N S E W (circle one) 	Panel Group: Azimuth: Tilt: Sheet _ of _			Customer Information:				DTU Serial Number:						
		1	2	3	4	5	6	7	8	9	10	11	12	13	14
A															
B															
C															
D															
To sheet _____															

6. Site Creation on HMP

- A. Install Hoymiles Installer APP by searching “Hoymiles” at the App Store (IOS) or Play Store (Android).
- B. Open the APP and login in with your installer account name and password. If you are a new installer with Hoymiles, please apply an Installer account from your distributor in advance.
- C. Add Station, select the “Station” tab on the bottom, then select “⊕” on the right top side of the page.
- D. Select “Quick” for Single-DTU and “Profession” for Multi-DTU.
- E. Please fill in the station details accordingly, and press “Next” after completed.
- F. Press “Add DTU ID”, scan the DTU ID (or you can manually input ID) and press “Next” after complete.
- G. Click “Start binding” and choose the angle and tilt base on the installation.
- H. Scan the Microinverter ID (or you can manually input the ID) and click the tick after completing each ID input. Press “Finish” once all Microinverter ID has been input.
- I. Disable the Scan function on the top of the right-hand side and design the Layout base on the installation. Click the tick box on the top of the right-hand side, and then select “Next” after completing the design.
- J. Upload a picture of the site and select “Finish” to complete the site creation.
- K. The new site will appear on the Station list from the Installer account.
- L. Please click the “Networking” button after the power station is created.
- M. Please wait about 30 minutes, the station will show online, and all the MI-IDs are found.

7. Customer Login

- a. Please download the End User App. You can search “Hoymiles” at the App Store (IOS) or Play Store (Android).
- b. Log in with the Password and Username that has been set up by Installer on the previous step (Section 6 step e), and press “Login”.
- c. Customers will able to view all details once the data start to upload, normally it will need around 30 mins for the first data coming through.
- d. Customer can also view the Microinverter generating details via accessing the HMP monitoring platform website at <https://world.hoymiles.com>.

8. Browse the Web Station

Log in your account and browse the web station.

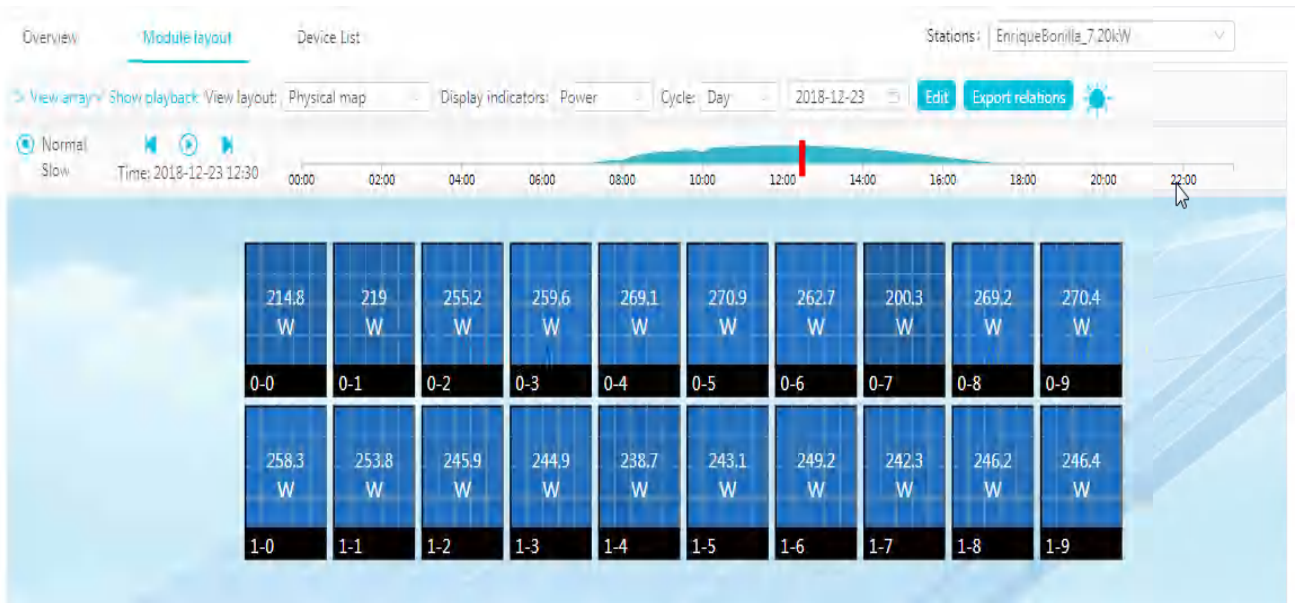





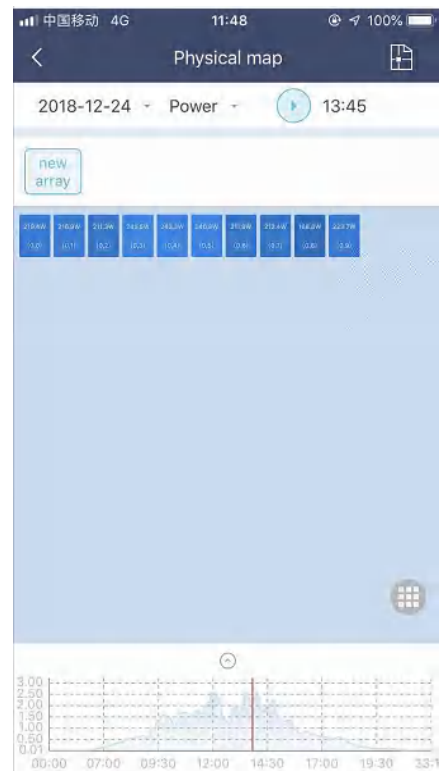



9. View Phone APP

Download mobile phone APP and view station information.











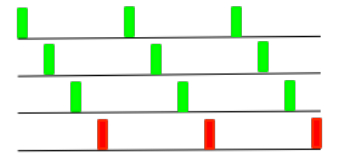
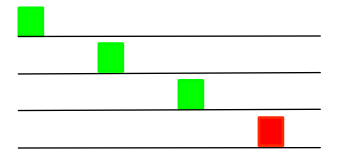

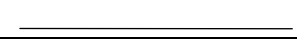





10. LED Indicators

The system status can be viewed by Hoymiles local APP or LED indicators.

LED mark	LED Color	Explanation
		DTU power on or power off
		Network communication
		Microinverter communication
		Fault State

LED States

LED Indicator	Status	Description
All		Firmware upgrading
		Starting up
		DTU power on
		DTU power off
		DTU are communicating with Hoymiles Monitoring Server
		Internet disconnected
		Internet connected, Server disconnected
		Local APP connected
		Microinverters are communicating
		MI IDs Incomplete
		No MI ID (Please perform Networking)
		Normal
		DTU alarm occurred
		Microinverter alarm occurred
		Meter alarm occurred

11. Technical Data

Model	DTU-PRO (WIFI Version)	DTU-PRO (GPRS Version)
Type	2.4GHz Proprietary RF (Nordic)	
Maximum distance (open space)	200m	
Monitoring data limit from solar panels	99 ²	
Communication to Cloud		
Type	WIFI(802.11b/g/n) ¹ /Ethernet	GSM(850/900/1800/1900MHz) ¹ / Ethernet
Sample rate	Per 15 minutes	
Communication to Meter		
Signal	RS485	
Maximum distance (RS485 cable)	500m	
Display		
LED	LED Indicator * 4 – RUN, Cloud, MI, ALM	
APP	Local APP	
Power Supply		
Type	External plug-in adapter	
Adapter input voltage/frequency	100 to 240 V AC / 50 or 60Hz	
Adapter output voltage/current	5V / 2A	
Power consumption	2.5W (typical), 5W (maximum)	
Mechanical Data		
Ambient temperature (°C)	-20°C to 55°C	
Dimensions (W×H×D)	200mm×101mm×29mm	
Weight	0.20 kg	
Mounting system	Wall mounting / Desktop mounting	
Features		
Compliance	FCC 15B, FCC 15C, EN60950-1, EN61000-3-2, EN61000-3-3, EN301489, EN300328, EN300440, RCM	
*1 If the DTU installation location is inside the metal box or under the metal/concrete roof, extended antenna will be suggested.		
*2 Depending on the installation environment, please refer to user manual for more details.		